

Plug in power supply

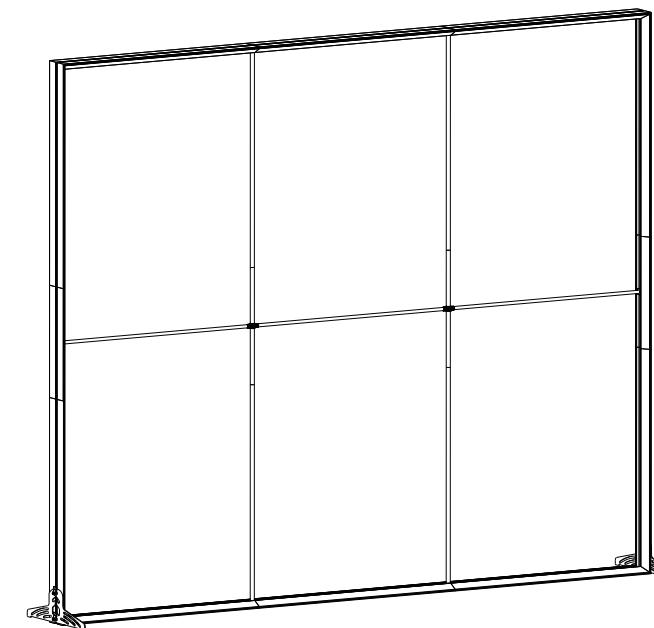

Note: size and assembly instructions displayed on this page are for the full size LightenUpTM frame. For the reduced height size (8'x6.5'), please review alternate instructions on page 2 before assembling frame.

Assembly Instructions



Frame Size: 8'x6.5'
(reduced height size)

1.

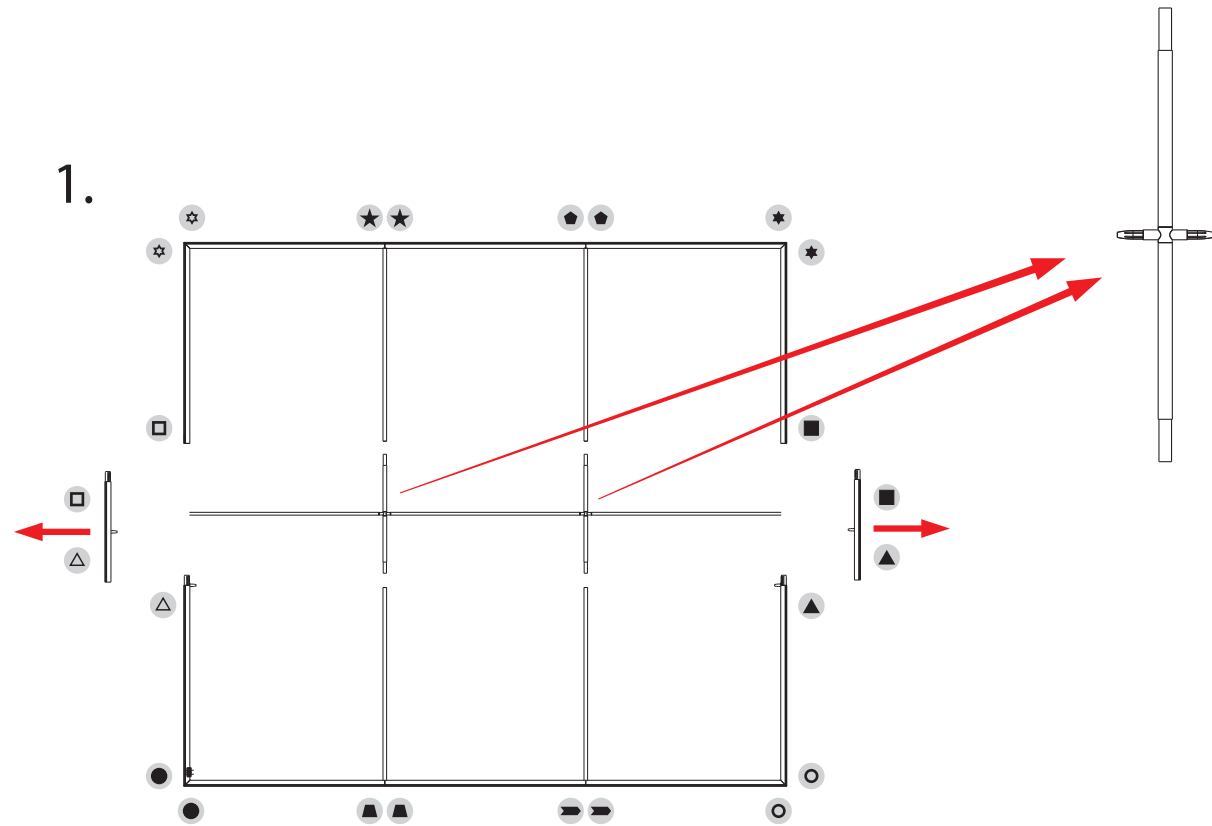

Remove Center Extrusion and Cross Bar Connector

2.

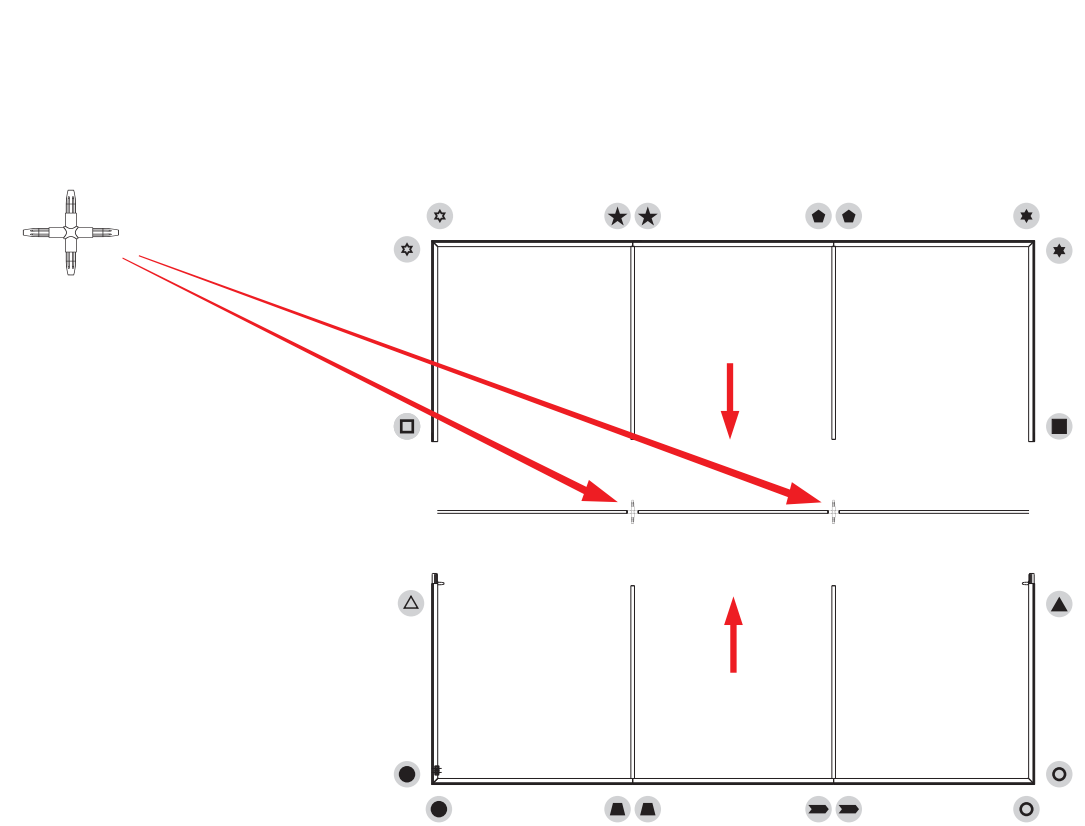

Add Reduced Height center Cross Bar Connector

3.

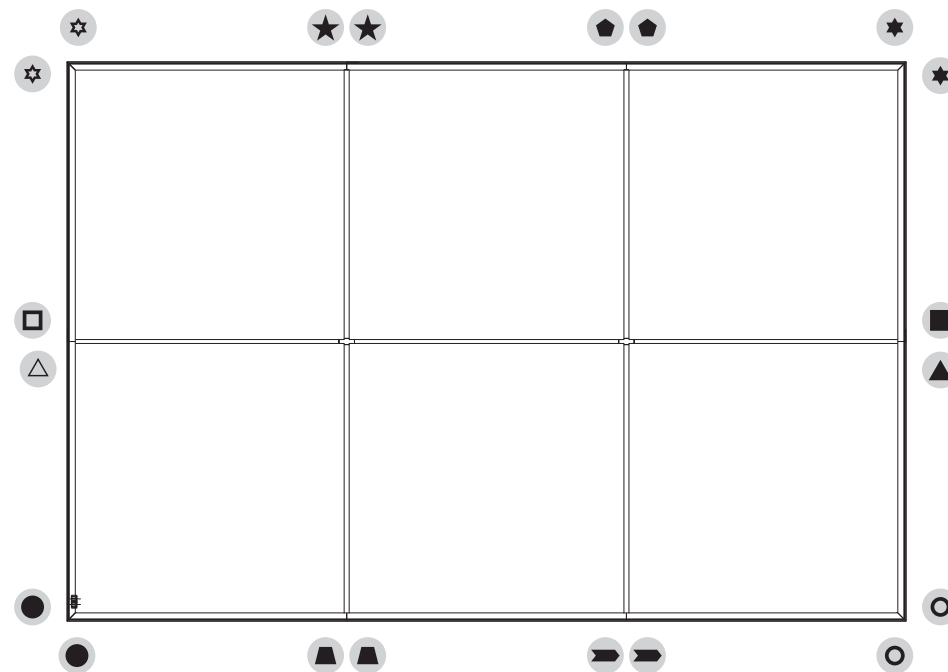

Graphic Installation Instructions



1 First, insert silicone edge graphic into all 4 corners

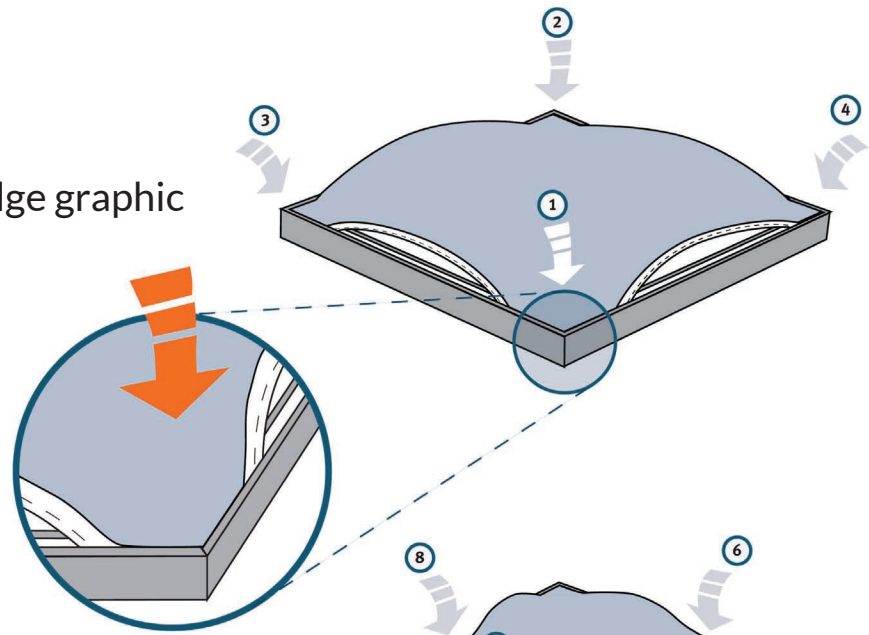

2 Next, insert graphic into the middle of all 4 sides

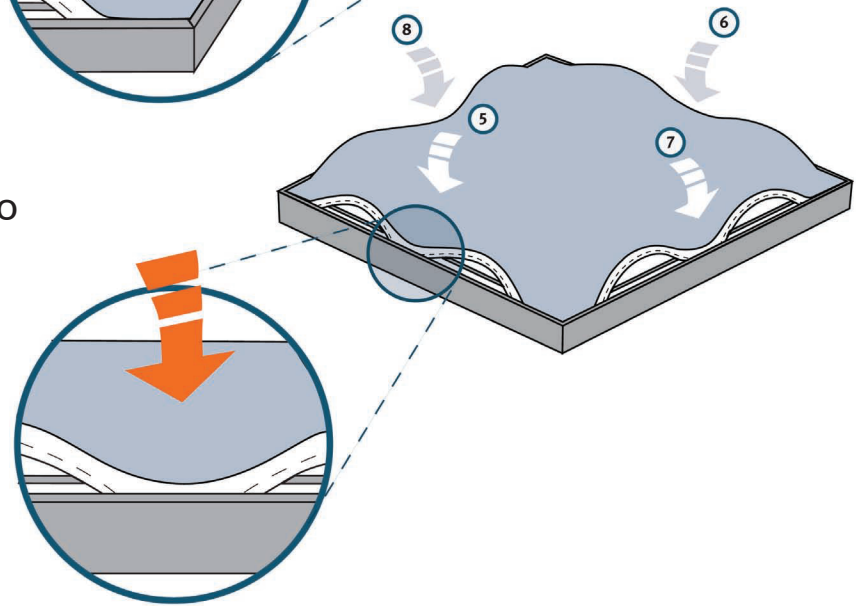

3 Starting in the center of each side, slowly insert graphic, working your way towards the corners

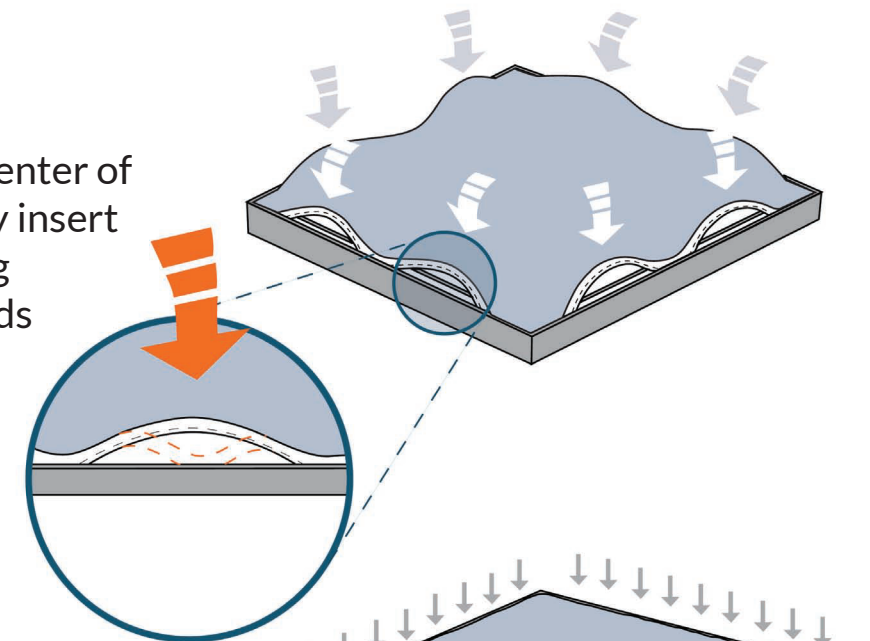

4 Repeat step 3 for each side until the graphic is smoothly inserted all the way around the frame

